



Podiatri
Sektörünün
Güvenilir Alman
Markası

 **RUCK**[®]

Ayak sağlığı ile ilgili herşey...



Ayak Saęlıęınız
Bizim İin nemli...





HİZMETLERİMİZ

- Anahtar Teslim Merkezler
- Medikal Ayak Bakım Kabinleri
- Ekipman Destek ve Yedek Parça
- Teknik Servis
- Eğitim
- **peclavus**[®] Ayak Sağlığı ve Kozmetik Ürünleri



85 YILLIK RUCK TECRÜBESİ

PODOLOGSTELLA² KONSEPT



14023

Set içeriği :

- 10011** **PODOLOGSTELLA² Medikal Koltuğu**
- 10115** BIOSWING Uzman koltuğu
- 11000** **PODOLOGNOVA³ Ayak bakım cihazı**
- 1023402** **PODOLOGML UV Bölmeli Alet Dolabı**
- 10210** Paslanmaz Çelik Çöp Kutusu
- 10215** Paslanmaz Çelik Alet Tepsisi
- 1205502** **PODOLOGCIRCLE XL Büyüteçli Aydınlatma (Lup)**



BENZERSİZ BİR KONSEPT



10011

PODOLOGSTELLA² Medikal Koltuğu

• 1 Sınıf Tıbbi Ekipman

- Sağlık Sektörü
- Podiatrik Alanlar
- Kozmetoloji
- SPA Salonları
- Estetisyenler
- Ayak Sağlığı Alanı
- Masaj Terapistleri

ve bunun gibi birçok sektörde kullanabileceğiniz

eşsiz bir ürün.

Teknik Özellikler:

Kol dayanakları dahil toplam genişlik : 82 cm

Toplam Uzunluk (bacak dayanakları çekilmiş halde) : 202 cm

Maksimum oturma yüksekliği: 100 cm

En alt kademe oturma yüksekliği: 53 cm

Bacak dayanakları ile maksimum yükseklik: 138 cm

Bacak dayanaklarının maksimum uzunluğu: 29 cm

Kaldırma kapasitesi: 200 kg (TÜV onaylı)

Optimal dönüş: 180°

Test edilmiş elektrik güvenliği: DIN EN 60601-2-38 / 60601-1-2

Trafo nominal gücü: 155 VA

Koruma sınıfı: IP44

Güç bağlantısı: 100-230 V

Toplam ağırlık (Yaklaşık): 140 kg



ESNEKLİK

Senkronize hareketli,
ayarlanabilir kol dayanağı.



Her iki yönde hareketli
kullanım



Hareketli
Ayak ve dayama



2 YIL
GARANTİ



NAKLİYE



KURULUM

GEÇMİŞTEN
GELEN
KALİTE
85
Y I L

www.ruckayaksagligi.com

Ağırlık Testi!

200 kg taşıma kapasitesi



BAŞLIK

Ayarlanabilir başlık.

KOMFOR

Vücut temasını rahatlatan yumuşak kenarlar

KOLTUK VE ARKALIĞI

Kolay değiştirilebilir yüksek kaliteli deri döşeme.

KOLTUK

Konfor ve yüksek taşıma kapasiteli çift yay sistemi.

BACAK DAYANAĞI

Açısı ayarlanabilir bacak arkılığı

AYAK DAYANAĞI

Ergonomik yuvarlak şekli ve hareketli fonksiyonu ile kolay kullanım.

GERME KOLU

Bacak boyu ayarlama kolu.

KOLLUKLAR

Senkronize hareketli, ayarlanabilir.

ÇELİK YAPI

İstikrarlı ve dayanıklı, uzun ömürlü kullanım.

GAZ BASINÇLI YAYLAR

Bacak dayanak ayar kolu.

İKİLİ ÇÖZÜM KOLU

Ayar erişim kolu

TABAN ELEMANI

Optimum hareket özgürlüğü, kolay temizlenme.

DENGELEYİCİ

AYAKLAR
Zemine göre ayarlanabilir hareketli ayaklar.

EL KUMANDASI

Opsiyonel

AYAK KUMANDASI

Su geçirmeyen ve kolay kullanım rahatlığı

ERGONOMİK ÇALIŞMA

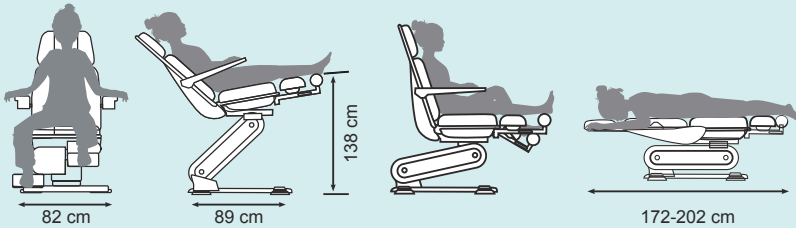

| | | | | | | | |
|----------------|------------------|---------------|-------------------|----------------|------------------|--------------|----------------|
| | | | | | | | |
| papaya (01) | schiefer (02) | terra (03) | brombeere (04) | baltic (05) | hellblau (06) | mint (07) | bambus (08) |

STELLA Konsept / 14031



Set İeriđi :

- 10001** STELLA Podiatri Koltuđu
- 10115** BIOSWING Uzman koltuđu
- 11000** **PODOLOGNOVA³** Ayak bakım cihazı
- 1023502** **PODOLOGXL** UV Bölmeli Alet Dolabı
- 10210** Paslanmaz Çelik Çöp Kutusu
- 10215** Paslanmaz Çelik Alet Tepsisi
- 1205502** **PODOLOGCIRCLE XL** Büyüteđli Aydınlatma (Lup)

10001

STELLA Podiatri Koltuğu









- 180 derece dönüş, çift motorlu.
- 120 cm yüksekliğe kadar çalışma imkanı
- Her iki yöne döndürebilme imkanı
- Gaz basınçlı yaylı bacak dayanakları



Teknik Özellikler:

Kol dayanakları dahil Toplam genişlik: 84 cm
Toplam Uzunluk (Bacak dayanakları çekilmiş halde): 206 cm
En alt kademe oturma yüksekliği: 55 cm
Maksimum Oturma yüksekliği: 100 cm
Bacak dayanakları ile maksimum yükseklik: 120 cm
Bacak dayanaklarının maksimum uzunluğu: 27 cm
Kaldırma kapasitesi: 150 kg
Optimal dönüş: 180°
Test edilmiş elektrik güvenliği: DIN EN 60601-2-38 / 60601-1-2
Trafo nominal gücü: 75 VA, Sınıf 2 B tipi
Güç kaynağı 230 V
Yaklaşık ağırlık: 110 kg



| | | | | | | | |
|--|---|---|---|---|---|---|---|
|  |  |  |  |  |  |  |  |
| grau / papaya (01) | grau / schiefer (02) | grau / terra (03) | grau / brombeere (04) | grau / baltic (05) | grau / hellblau (06) | grau / mint (07) | grau / bambus (08) |



www.ruckayaksagligi.com

2 YIL
GARANTİ



GEÇMİŞTEN
GELEN
KALİTE
85
Y I L

SASKIA Konsept / 14061



Set İeriđi :

- 10010 SASKIA Podiatri Koltuđu
- 10139 RUCK Uzman koltuđu ERGO
- 11011 **PODOLOGNOVA** Ayak bakım cihazı
- 1022402 **PODOLOGML** Alet Dolabı
- 10210 Paslanmaz elik öp Kutusu
- 10215 Paslanmaz elik Alet Tepsisi
- 1205402 **PODOLOGCIRCLE XLB**üyüteđli Aydınlatma (Lup)

10010

SASKIA Podiatri Koltuğu

- Elektromotorlu yükseklik ayarı
- 90 derece dönüş, tek motorlu.
- 105 cm yüksekliğe kadar çalışma imkanı
- Her iki yöne döndürebilme imkanı
- Gaz basınçlı yaylı bacak dayanakları



Teknik Özellikler:

Elektro motorlu yükseklik ayarı.

Gaz basıncı yayı ile Trendelenburg koltuk ayarı.

Gaz basınç yayı ile tam düzlük kadar sırt ayarı.

Bacak dayanaklarının yüksekliği ayarlanabilir.

Uzatılabilir bacak dayanakları.

Yaklaşık ağırlık: 86 kg.

Koltuk oturma yüksekliği 60-80 cm

Bacak dayanakları ile maksimum yükseklik: 105 cm

Boyutlar:

Koltuk : 52 x 54 cm.

Toplam genişlik : 67 cm.

Bacak dayanakları ile (uzatılmış) yaklaşık 67 cm.



papaya (01) schiefer (02) terra (03) brombeere (04) baltic (05) hellblau (06) mint (07) bambus (08) telegrau (09)



www.ruckayaksagligi.com

2 YIL
GARANTİ



GEÇMİŞTEN
GELEN
KALİTE
85
Y I L

SELINA Konsept / 14065



Set İeriđi :

- 10029** SELINA Podiatri Koltuđu
- 10130** RUCK Uzman koltuđu KOMFORT
- 11005** **PODOLOGECO** Ayak bakım cihazı
- 1023302** **PODOLOGL** Alet Dolabı
- 10210** Paslanmaz elik öp Kutusu
- 10215** Paslanmaz elik Alet Tepsisi
- 12070** IQ Led Büyüteç (Lup)

10029

SELINA Podiatri Koltuđu

- Güçlü yağ hidroliđi.
- 117 cm yüksekliđe kadar çalıřma imkanı
- Sedye konumuna getirilebilme imkanı
- Gaz basınç yayı ile ayarlanabilir koltuk



Teknik Özellikler:

Yağ pompası ile koltuk yüksekliđi ayarı
Gaz basıncı yayı ile Trendelenburg koltuk ayarı
Sedye haline getirmek için manuel ayar
Oturma alanı (G x D) 52 x 54 cm
Koltuk yüksekliđi yaklaşık: 54 - 74 cm
Genel genişlik: 67 cm
2 parçalı bacak destekleri (uzatılmış)
maksimum uzunluk: 67 cm
Maksimum taban yüksekliđi: 117 cm
Toplam ađırlık: 77 kg



| | | | | | | | | |
|----------------|------------------|---------------|-------------------|----------------|------------------|--------------|----------------|------------------|
| papaya (01) | schiefer (02) | terra (03) | brombeere (04) | baltic (05) | hellblau (06) | mint (07) | bambus (08) | telegrau (09) |
|----------------|------------------|---------------|-------------------|----------------|------------------|--------------|----------------|------------------|



www.ruckayagsagligi.com

2 YIL
GARANTİ



GEÇMİŐTEN
GELEN
KALİTE
85
Y I L

SARA Konsept / 14067



Set İeriđi :

- 10004 SARA Podiatri Koltuđu
- 10131 RUCK Uzman koltuđu
- 11005 **PODOLOGECO** Ayak bakım cihazı
- 1022302 **PODOLOGL** Alet Dolabı
- 10210 Paslanmaz elik öp Kutusu
- 10215 Paslanmaz elik Alet Tepsisi
- 12000 Waldmann LRE 122 Büyüte (Lup)

10004

SARA Podiatri Koltuğu

- Güçlü yağ hidroliji.
- Sirt dayanađı 30° derece yatırılabilir
- Maksimum ayak yüksekliđi 87cm
- Uzatılabilir ayak dayanakları



Teknik Özellikler:

Yađ pompası ile koltuk yüksekliđi ayarı

Senkron mekanizması ile 30° mit sirt dayanađı eğimi

Oturma alanı (G x D) yaklaşık. 52 x 45 cm

Oturma yüksekliđi: 54 - 70 cm.

Yaklaşık genişlik: 67 cm.

2 parçalı bacak destekleri (uzatılmış)

maksimum uzunluk: 65 cm

Maksimum ayak yüksekliđi: 87 cm

Yaklaşık ađırlık: 34 kg



papaya (01) schiefer (02) terra (03) brombeere (04) baltic (05) hellblau (06) mint (07) bambus (08) telegrau (09)



www.ruckayagsagligi.com

2 YIL GARANTİ



GEÇMİŞTEN
GELEN
KALİTE
85
YIL

PODOLOG DOLAPLAR

* Dolaplara Podoloji Cihazları Dahil Değildir.



1023306

PODOLOG L
UV Hazneli Dolap

- 4 Çekmece
- 1 Gömme dolap
- 8 Watt UVC lambalı hazne

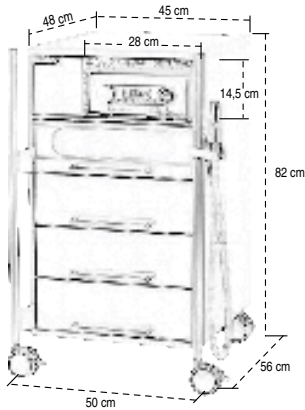

1023402

PODOLOG ML
UV Hazneli Dolap

- 4 Çekmece
- 1 Gömme dolap
- 8 Watt UVC lambalı hazne

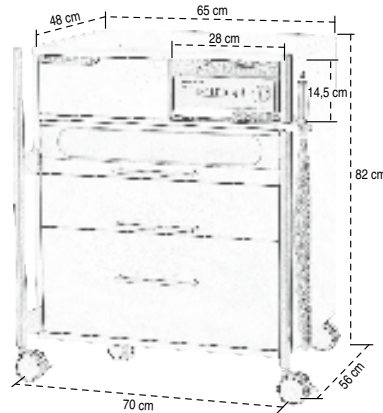

1023502

PODOLOG XL
UV Hazneli Dolap

- 4 Çekmece
- 1 Gömme dolap
- 8 Watt UVC lambalı hazne

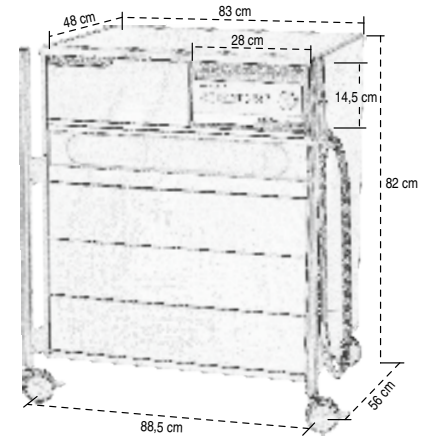

www.ruckayaksagligi.com



lichtgrau (01)



weiß (02)



Hochglanz weiß (03)



Nussbaum (04)



Birke (05)



Buche (06)

PODOLOG CIRCLE XL

1205501PODOLOGCIRCLE XL professionalBlack Edition

1205502PODOLOGCIRCLE XL professionalWhite Edition

Renk Sıcaklığı :4000 K nötr beyaz

150 mm'lik bir çalışma mesafesindeki aydınlık: 6000 lux

Tekrar renk oluşturma (CRI) = 90

Aydınlatma : Ø 240 mm

Lens Alanı : 153 mm

Lup gücü : 3.5 diyoptri

48 adet yüksek güçlü LED

Güç tüketimi : 6 watt

Voltaj: 100-240 V, 50/60 Hz

DIMM fonksiyonlu açma / kapama şalteri



PODOLOG CIRCLE XL

1205401PODOLOGCIRCLE XL classicBlack Edition

1205402PODOLOGCIRCLE XL classicWhite Edition

Renk Sıcaklığı :4000 K nötr beyaz

150 mm'lik bir çalışma mesafesindeki aydınlık: 6000 lux

Tekrar renk oluşturma (CRI) = 90

Aydınlatma : Ø 240 mm

Lens Alanı : 153 mm

Lup gücü : 3.5 diyoptri

48 adet yüksek güçlü LED

Güç tüketimi : 6 watt

Voltaj: 100-240 V, 50/60 Hz

DIMM fonksiyonlu açma / kapama şalteri



12009 Tekerlekli Ayak

Yükseklik : 56 cm

Ayak ölçüleri: 46 x 46 cm

CIRCLE S mobilBlack Edition

12002

Renk Sıcaklığı :4000 K

12000 Waldmann Büyüteçli Lup RLL 122 Beyaz

Tekrar renk oluşturma (CRI) = 80

Aydınlatma : Ø 120 mm

Lup gücü : 4 diyoptri

Güç tüketimi : 22 watt

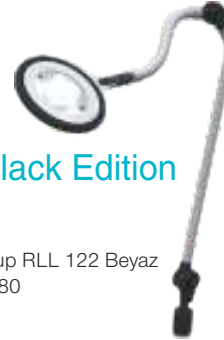

CIRCLE S BASIC

12006

Renk Sıcaklığı :4000 K nötr beyaz

150 mm'lik alandaki aydınlık: 5200 lux

Tekrar renk oluşturma (CRI) = 85

Aydınlatma : Ø 122 mm

Lens Alanı : 72 mm

Kalınlık : 12 mm

Lup gücü : 6 diyoptri

63 adet yüksek güçlü LED

Güç tüketimi : 6 watt

Voltaj: 100-240 V, 50/60 Hz

Luxo CIRCUS

12004 Siyah / Beyaz

Renk Sıcaklığı :4000 K

Üç noktadan bükülen kol (uzunluk 1000 mm)

Kolayca ayarlanabilen alüminyum aydınlatma başlığı

280 mm'lik alandaki aydınlatma: 3500 lux

Tekrar renk oluşturma (CRI) = 80

Aydınlatma : Ø 120 mm

Yuvarlak Cam Lens : 3,5 diyoptri, %185 Büyütme

Güç tüketimi : 22 watt T5Floresan

Lamba Ömrü : 10.000 Saat

12039 Luxo metal kelepçe 0-70 mm açıklık

12038 Luxo Duvara montaj aparatı

12016 Waldmann tezgah kelepçesi 0-140 mm açıklık



2 YIL
GARANTİ



www.ruckayaksagligi.com

PODOLOGNOVA³



11000

Ünitenin ölçüleri: 251/228/105 (mm)
Ağırlık: Ort. 2650 g
El aletinin uzunluğu: 127 mm
El aletinin ağırlığı: Ort. 120 g
Kontrol ünitesi gerilimi: 115-220 V, 50-60 Hz
Rölanti hızı: 40.000 (Devir/Dakika)
Tam güçte azami hacim akımı: ort. 280 l/Dakika
Garanti (Aşınma parçaları hariç): 2 yıl

PODOLOGECO



11011

Ünitenin ölçüleri G/D/Y: 256/258/135 mm
Ağırlık: ort. 3.9Kg
El aletinin uzunluğu: 120 mm
El aletinin ağırlığı: ort. 95 g
Kontrol ünitesi gerilimi: 115-220 V, 50-60 Hz
Rölanti hızı: 4000-30.000 (Devir/Dakika)
Tam güçte azami hacim akımı: ort. 215 l/Dakika
Garanti (Aşınma parçaları hariç): 2 yıl

PODOLOGONE



11012

Ünitenin ölçüleri G/D/Y: 250/235/120 (mm)
Ağırlık: ort. 3300 g
El aletinin uzunluğu: 122 mm
El aletinin ağırlığı: ort. 120 g
Kontrol ünitesi gerilimi: 115-220 V, 50-60 Hz
Rölanti hızı: 4000-25.000 (Devir/Dakika)
Tam güçte azami hacim akımı: ort. 170 l/Dakika
Garanti (Aşınma parçaları hariç): 2 yıl

PODOLOGPOCKET



11016

Rölanti hızı: 1000-30.000 (Devir/Dakika)
Garanti (Aşınma parçaları hariç): 2 yıl

2 YIL
GARANTİ

www.ruckayaksagligi.com

PODOLOGPOCKET

11101



PODOLOGECO mobil

1113002



PODOLOGNOVA³ mobil

1100802 / All in One



11188

PODOLOGONE mobil

1113402



MOBİL BAŞLANGIÇ SETLERİ

3701902



PODOLOGNOVA³mobil



2 YIL
GARANTİ

www.ruckayaksagligi.com

MOBİL BAŞLANGIÇ SETLERİ

PODOLOGECO mobil



3703002



2 YIL
GARANTİ



www.ruckayaksagligi.com

MOBİL EKİPMANLAR

1122701



MOBİL EKİPMANLAR



Dezenfekte ve Sterilizasyon Cihazları

PODOLOGSONIC S Ultrasonik Cihaz

2603501
19 x 8,5 cm.
240 Watt.
Paslanmaz çelik
0,9 Lt



PODOLOGSONIC M Ultrasonik Cihaz

2603502
24 x 14 cm.
240 Watt.
Paslanmaz çelik
3 Lt



PODOLOGSONIC XL Ultrasonik Cihaz

2603501
30 x 25 cm.
240 Watt.
Paslanmaz çelik
4,3 Lt

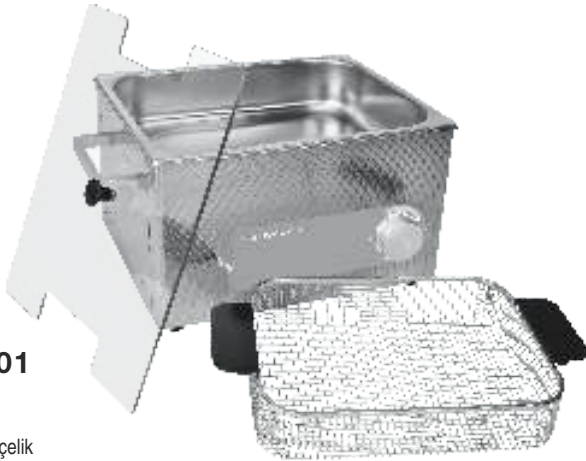

MELAG TYP 75 Sıcak Buhar Sterilizatörü

26034

İki Tepsili
İç Ölçü (G x Y x D): 19,5 x 7,4 x 29,5 cm
Dış Ölçü (G x Y x D): 31 x 26 x 39,5 cm
Gerilim: 230 V/50 Hz / 650 Watt
Ağırlık: 12 kg
Hacim: 4 Lt



Dezenfekte ve Sterilizasyon

MELAtronic 15 EN+

Otoklav

26064

Üç Tepsili

İç Ölçü (G x D): Ø15 x 38 cm

Dış Ölçü (G x Y x D): 50 x 44 x 33 cm

Gerilim: 230 V/50 Hz / 1.500 Watt

Ağırlık: 22 kg

Hacim: 7 Litre



Euroklav 29 VS+

Otoklav

26094

Beş Tepsili

İç Ölçü (G x D): Ø25 x 35 cm

Dış Ölçü (G x Y x D): 57 x 42,5 x 48,5 cm

Gerilim: 230 V/50 Hz / 2.300 Watt

Ağırlık: 43 kg

Hacim: 18 Litre



Steril Alet Poşetleme ve Etiketleme

26440

Etiketleme Cihazı



26040

MELAseal 100+



Ayak Banyosu Arabası

46009

Ölçü : 37 x 38 cm

Yükseklik : 94 cm

(Aski ile birlikte)



TIRNAK KESİCİLER

21058 Mini Tırnakucu Kesici

Paslanmaz çelik
Ort. Uzunluk 10 cm.
Tek taraflı sivri uçlu manşet kesici,
hafif kullanım için uygun form.

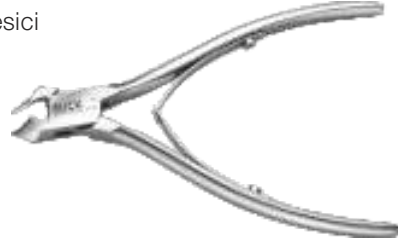

21052 Tırnakucu Kesici

Paslanmaz çelik
Ort. Uzunluk 13,5 cm.
Tek taraflı sivri uçlu.



21059 Tırnakucu Kesici

Paslanmaz çelik
Ort. Uzunluk 11,5 cm.
İki eşit ve klasik boynuz uçlu manşet kesici.
Hafif kullanım için uygun form.

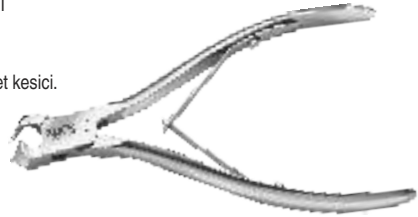

21060 Tırnakucu Kesici

Paslanmaz çelik
Ort. Uzunluk 13,5 cm.
İçe dönük oyuklu kesici yüzey.



21061 Tırnakucu Kesici / Köşe Pens

Paslanmaz çelik, Ort. Uzunluk 14 cm.
Bu manşet kesici gerçek bir çiftli alettir. Uzatılmış ve keskinliği artırılmış ucuyla köşeli pense gibi de kullanılabilir ve çoğu tırnak kıvrımları üzerinde çalışabilmek için de gayet uygundur.



20310 Tırnakucu Kesici

Paslanmaz çelik
Ort. Uzunluk 13,5 cm.
Küçük kesici yüzey
(kısa boynuz).



20210 Tırnakucu Kesici

Paslanmaz çelik
Ort. Uzunluk 13,5 cm.
Oyuklu kesici alan.



21241 Tampon Yaylı Tırnak Pensi

Paslanmaz çelik / Ort. Uzunluk 11,5 cm.
Uzun ömürlü tampon yaylı sistemli ele uygun
stabil tırnak pensi, özellikle aşırı kalın
tırnaklar için uygun geliştirilmiştir.



21333 Tırnak Pensi

Paslanmaz çelik / Ort. Uzunluk 12 cm.
Bu tırnak pensi çift destek ile gücünüzü katlar.
Stabil tampon yay size fazla güç gereksinimi duymadan
kesim yapmanızı sağlar.

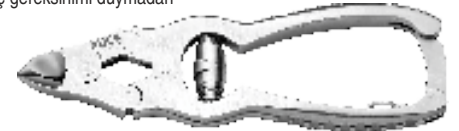

21336 Tırnak Pensi

Paslanmaz çelik, Ort. Uzunluk 13 cm.

Hafif kubbeli kesici yüzey. Ekstra durumlar için bile temiz kesim imkanı sunar. Ergonomik formu en uygun tutuş imkânını verir ve en önemlisi, en sert tırnakları bile rahat kesme imkânı sunar.



21332 Sertleştirilmiş Uçlu Tırnak Pensi

Paslanmaz çelik / Ort. Uzunluk 14 cm.

Özel dövülmüş sert metalden oluşan kavisli kesici yüzey. Sert tırnaklar için uygundur. Eksiksiz kesim ve çok uzun kullanım ömrü.



20214 Tırnakucu Kesici

Paslanmaz çelik

Ort. Uzunluk 15 cm.

Güç tasarrufu sağlayan kavisli kesici.



21000 Tırnak Pensi

Paslanmaz çelik.

Ort. Uzunluk 14,5 cm.

Hafif oyuklu kesici yüzey.



21266 Aralıklı Tırnak Pensi

Paslanmaz çelik

Ort. Uzunluk 13,5 cm.

Özel tırnak çalışmaları için çift yaylı pens.



20666 Tırnakucu Pensi

Paslanmaz çelik

Ort. Uzunluk 13 cm.

Narin formu, içe dönük oyuklu kesici yüzey.

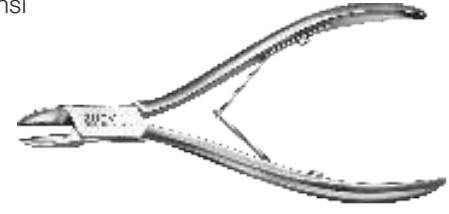

20241 Tırnak Pensi

Paslanmaz çelik / Ort. Uzunluk 12 cm.

Paslanmaz çelikten imal edilmiş tampon yaylı hafif oyuklu kesici yüzey.



20063 Tırnak Pensi

Paslanmaz çelik

Ort. Uzunluk 15 cm. Çift katmanlı.

Az kuvvet ile kolay kesim imkanı sunar.



21262 Tırnak Pensi

Paslanmaz çelik / Ort. Uzunluk 13,5 cm.

Hafif oluklu kesici yüzey ve paslanmaz çelikten imal edilmiş tampon yay.



KÖŞE PENSLER

21164 Köşe Pens

Paslanmaz çelik
Ort. Uzunluk 10 cm.
İnce, küçük kesici yüzey.



21068 Köşe Pens

Paslanmaz çelik
Ort. Uzunluk 11,5 cm.
Oldukça uzun ve dar uç.



21168 Köşe Pens

Paslanmaz çelik
Ort. Uzunluk 11,5 cm.
Uzun ve ince kesici yüzey.

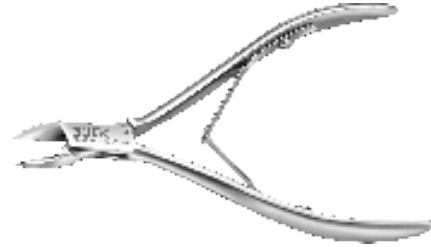

21065 Köşe Pens

Paslanmaz çelik
Ort. Uzunluk 11 cm.
Dar kesici yüzey.



21067 Köşe Pens

Paslanmaz çelik,
Ort. Uzunluk 13 cm.
Oldukça dar ve uzun uç,
özellikle zor tırnak katmanları için uygun.



21334 Tırnak / Köşe Pens

Paslanmaz çelik / Ort. Uzunluk 13 cm. Yuvarlatılmış uç ve kenarlar.
Diabetik ayaklar için profesyonel kalitedir.
Kısa tırnaklar dışında köşe kesimi için de dizayn edilmiştir.
Özellikle uzun eller için geliştirilmiştir.

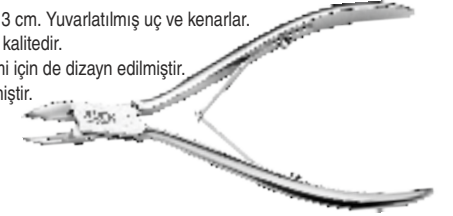

21335 Tırnak / Köşe Pens

Paslanmaz çelik / Ort. Uzunluk 11 cm. Yuvarlatılmış uç ve kenarlar.
Diabetik ayaklar için profesyonel kalitedir.
Kısa tırnaklar dışında köşe kesimi için de dizayn edilmiştir.
Özellikle küçük eller için geliştirilmiştir.

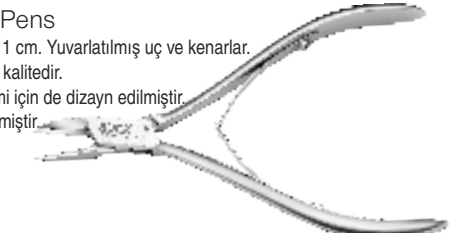

20478 Köşe Pens

Paslanmaz çelik
Ort. Uzunluk 13 cm.
Normal ama güçlü kesici yüzey.



21066 Köşe Pens

Paslanmaz çelik
Ort. Uzunluk 11,5 cm.
İnce ve narin kesici yüzey.



20166 Köşe Pens

Paslanmaz çelik.
Ort. Uzunluk 11,5 cm.
Normal ve düz kesici yüzey.



21343 Köşe Pens

Paslanmaz çelik / Ort. Uzunluk 10 cm.
Derinlerde bulunan tırnak köşelerinde hassas çalışma için ekstra uzun ve dar kesim imkanı veren süper ince köşe pens.



Zarif formuyla küçük eller için de uygun.



Kalın ve sert tırnaklar için uygun değildir. Gerekliğinde tırnağı önceden bir freze ile inceltin.

20266 Köşe Pens

Paslanmaz çelik.
Ort. Uzunluk 11,5 cm.
Narin, sivri ve ekstra ince kesici yüzey.



21167 Köşe Pens

Paslanmaz çelik.
Ort. Uzunluk 13 cm.
Kolay uygulama için stabil kesici yüzey.



21174 Köşe Pens

Paslanmaz çelik / Ort. Uzunluk 13 cm.
Derinlerde bulunan tırnak köşelerine doğru ve düzgün çalışma için geliştirilmiş özellikle uzun ve dar kesim imkanı sunan köşe pens.



Kalın ve sert tırnaklar için uygun değildir. Gerekliğinde tırnağı önceden bir freze ile inceltin.

20566 Özel Model Köşe Pens

Paslanmaz çelik / Ort. Uzunluk 13 cm.
Uzun ve dar kesici yüzeyli. Özellikle ince tırnak katmanları için iri kavrama özelliği.



21004 Köşe Pens

Paslanmaz çelik / Ort. Uzunluk 15 cm.
Uzun tutma sapları, kaldıraç yayları, ince ve sivri ucuyla oldukça stabil uygulama imkanı sunar.

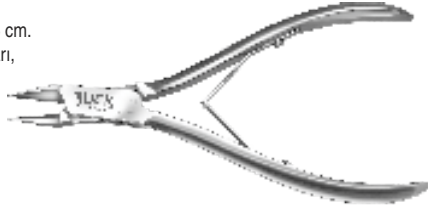

20567 Özel Köşe Tırnak Kesici

Paslanmaz çelik / Ort. Uzunluk 13,5 cm.
Kesme kenarı 7 mm.
Tüm nazik tırnak katmanları için uygundur.



Yumuşak yuvarlanmış kesici formuyla duyarlı ve çok derinde bulunan tırnak köşelerinin kesimi için idealdir.

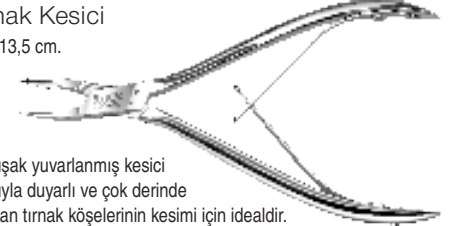

21001 Köşe Pens

Paslanmaz çelik
Ort. Uzunluk 13 cm.
Özellikle uzun ve dar uç.



21064 Kademeli Tırnak ve Köşe Pensi

Paslanmaz çelik / Ort. Uzunluk 14,5 cm. Tırnak ve tırnak köşeleri için yeni geliştirilmiştir. Baş kısmının kademeli oluşumuyla büyük bir stabilite sağlanmıştır. Çok zor görülen tırnak çalışmaları için bile rahat kullanım sağlar.



DERİ PENSLERİ

21180 Deri Pensi

Paslanmaz çelik.
Ort. Uzunluk 11,5 cm.
Kesme kenarı 10 mm.



21172 Deri Pensi

Paslanmaz çelik.
Ort. Uzunluk 8,5 cm.
Kesme kenarı 7 mm.
Makas kolu.



21082 Deri Pensi

Paslanmaz çelik.
Ort. Uzunluk 10 cm.
Kesme kenarı 4 mm

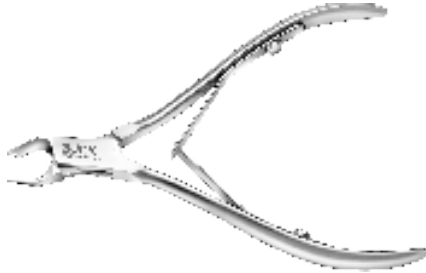

20081 Deri Pensi

Paslanmaz çelik.
Ort. Uzunluk 11,5 cm.
Kesme kenarı 8 mm.



21083 Deri Pensi

Paslanmaz çelik.
Ort. Uzunluk 10 cm.
Kesme kenarı 9 mm.



20080 Deri Pensi

Paslanmaz çelik.
Ort. Uzunluk 11,5 cm.
Kesme kenarı 10 mm.



21284 Deri Pensi

Paslanmaz çelik.
Ort. Uzunluk 10 cm.
Kesme kenarı 6 mm.

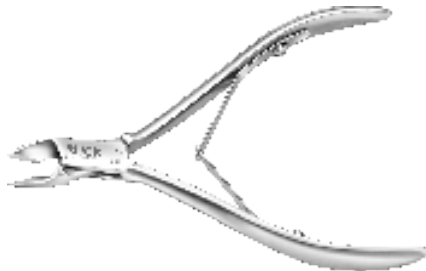

20460 Deri Pensi

Paslanmaz çelik.
Ort. Uzunluk 10 cm.
Kesme kenarı 7 mm.
Hafif yuvarlatılmış sap.



DERİ PENSLERİ

21170 Deri Pensi

Paslanmaz çelik.
Ort. Uzunluk 10 cm.
Kesme kenarı 7 mm.



21074 Deri Pensi

Paslanmaz çelik
Ort. Uzunluk 10 cm.
Kesme kenarı 8 mm.



20070 Deri Pensi

Paslanmaz çelik.
Ort. Uzunluk 10,5 cm.
Kesme kenarı 8 mm.



21175 Deri Pensi

Paslanmaz çelik / Ort. Uzunluk 10 cm.
Kesme kenarı 8 mm.
Deri ve tırnak derisi üzerinde
çalışırken oldukça duyarlı olan
kısa uçlu pens.



20440 Deri Pensi

Paslanmaz çelik.
Ort. Uzunluk 8,5 cm.
Kesme kenarı 3 mm.



20075 Deri Pensi

Paslanmaz çelik.
Ort. Uzunluk 10,5 cm.
Kesme kenarı 9 mm.

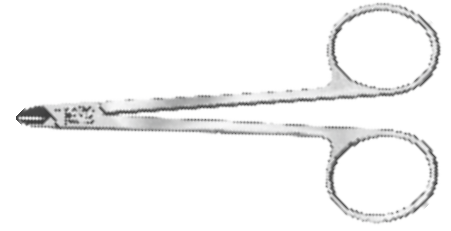

21071 Deri Pensi

Paslanmaz çelik. / Ort. Uzunluk 8,5 cm.
Kesme kenarı 8 mm.
Düz kesici yüzey. Özellikle
ayak tırnakları arasında
rahat çalışma imkanı.



2 YIL
GARANTİ

GEÇMİSTEN
GELEN
KALİTE
85
YIL



www.ruckayaksagligi.com

ÖZEL ALETLER

23131 Pürüzsüz Uçlu Düz Burun Pens

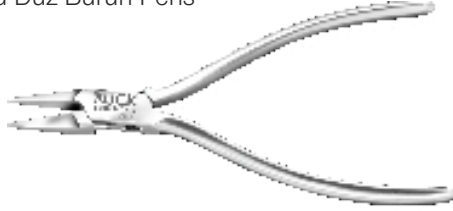

Paslanmaz çelik
Ort. Uzunluk 12,5 cm.

23022 Düz ve Pürüzsüz Uçlu Kargaburun Pens



Paslanmaz çelik
Ort. Uzunluk 14 cm.

23064 Yuvarlak ve Sivri Pens



Paslanmaz çelik
Ort. Uzunluk 11 cm.

23061 Yunus Başlı Pens



Paslanmaz çelik
Ort. Uzunluk 15,5 cm.

23063 Makas Cımbız



Paslanmaz çelik
Ort. Uzunluk 14 cm.

23066 Yaylı Tel Kesici

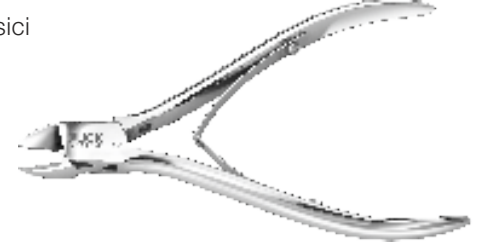

Paslanmaz çelik
Ort. Uzunluk 11 cm.

23073 Altın Tel Makası



Paslanmaz çelik
Ort. Uzunluk 10,5 cm.

23060 Kanca



Paslanmaz çelik

23026 Tel Kesici



Paslanmaz çelik
Ort. Uzunluk 13 cm.

23006 Portegü



Paslanmaz çelik
Ort. Uzunluk 17 cm.

23024 Kısa Uçlu ve Yivli Kargaburun Pens



Paslanmaz çelik
Ort. Uzunluk 13,5 cm.

23005 Yuvarlak Uçlu , Sivri ve Pürüzsüz Pens



Paslanmaz çelik
Ort. Uzunluk 12 cm.

21335 Tırnak-/Köşe Pens

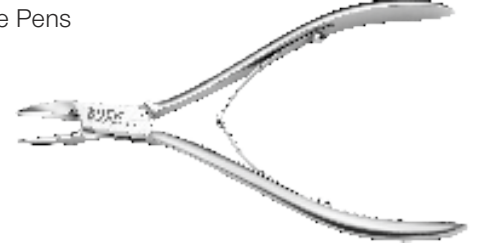

Paslanmaz çelik
Ort. Uzunluk 11 cm.

21334 Tırnak-/Köşe Pens

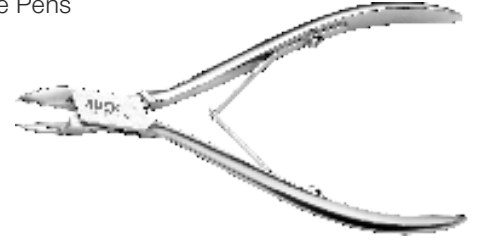

Paslanmaz çelik
Ort. Uzunluk 13 cm.

23065 Sivri ve Yuvarlak Uçlu Pens



Paslanmaz çelik
Ort. Uzunluk 13 cm.

2 YIL
GARANTİ

GEÇMİŞTEN
GELEN
KALİTE
85
YIL



www.ruckayaksagligi.com

SPATULALAR

20040 Çift Taraflı Tırnak Aleti

Paslanmaz Çelik.
Uzunluk : 17 cm



20333 Yuvarlatılmış İçi Boş Saplı Çift Taraflı Tırnak Aleti

Paslanmaz Çelik.
Uzunluk : 18,5 cm



20340 İçi Boş Saplı Çift Taraflı Tırnak Aleti

Paslanmaz Çelik.
Uzunluk : 17,5 cm



20056 Uçları Elmaslaştırılmış, Çift Taraflı Köşe Aleti

Paslanmaz Çelik.
Uzunluk : 14 cm



20049 Çift Taraflı Köşe Aleti; İnce, Düz Ve Eğimli

Paslanmaz Çelik.
Uzunluk : 13,5 cm



20043 Çift Taraflı Köşe Aleti, Bükülmüş ve Düz

Paslanmaz Çelik.
Uzunluk : 13,5 cm



20146 Uçları Oyulmuş Çift Taraflı Kaşık Alet

Paslanmaz Çelik.
Uzunluk : 17 cm



20133 Uçları Sivrileştirilmiş Çift Taraflı Tırnak Aleti

Paslanmaz Çelik.
Uzunluk : 16 cm



20033 Uçları Yuvarlatılmış Çift Taraflı Tırnak Aleti

Paslanmaz Çelik.
Uzunluk : 16 cm



20132 Tırnak Kıvrımı Bıçağı

Paslanmaz Çelik.
Uzunluk : 15 cm



20011 Kör Tampon Aleti

Paslanmaz Çelik.
Uzunluk : 13,5 cm



20034 Pamuk Kancası

Paslanmaz Çelik.
Uzunluk : 15 cm



20123 Temizleme Aleti

Paslanmaz Çelik.
Uzunluk : 13 cm



20343 Çizik Kalemi / 1 mm

Paslanmaz Çelik.
Uzunluk : 13,5 cm



BİSTURİ VE NEŞTERLER

20600 Tıbbi Kalem Bisturi Tutucu

Paslanmaz çelik.
Bisturi Tutucu
Uzunluk 12,8 cm.



Medikal Bisturi

En Üst Düzey Kalitede



20059 Medikal Bisturi / Karşık
(1V, 2V, 6 ve 10'dan 5'er Adet)



Paslanmaz Çelik



MAKASLAR

20094 Kıvrık Tırnak Makası

Paslanmaz çelik,
Uzunluk 9 cm.



21092 Sivri Deri Makası

Paslanmaz çelik,
Uzunluk 9 cm.



21093 Kıvrık Deri Makası

Paslanmaz çelik,
Uzunluk 9 cm.



20561 Tırnak Makası

Paslanmaz çelik,
Uzunluk 11 cm.



20281 Bebek Emniyetli Tırnak Makası

Paslanmaz çelik,
Uzunluk 9 cm.



21094 Bandaj için Kıvrık Makas

Paslanmaz çelik,
Uzunluk 11 cm.



21091 Bandaj Makası

Paslanmaz çelik,
Uzunluk 9 cm.



20860 Bandaj Makası

Paslanmaz çelik,
Uzunluk 14 cm.



21090 Özel Sertleştirilmiş Bandaj Makası

Paslanmaz çelik,
Uzunluk 14,5 cm.



20124 Manikür Sürgülü Cımbız

Paslanmaz Çelik.
Uzunluk : 9,5 cm



21045 Sivri Cımbız

Paslanmaz Çelik.
Uzunluk : 9,5 cm



21345 Düz Cımbız

Paslanmaz Çelik.
Uzunluk : 9,5 cm



21245 Eğimli Cımbız

Paslanmaz Çelik.
Uzunluk : 9,5 cm



2004201 Kıymık Cımbızı

Paslanmaz Çelik.
Uzunluk : 9 cm



2004202 Kıymık Cımbızı

Paslanmaz Çelik.
Uzunluk : 11,5 cm



20044 Anatomik Cımbız

Paslanmaz Çelik.
Uzunluk : 12 cm



20125 Deri Cımbızı

Paslanmaz Çelik.
Uzunluk : 10 cm



20221 Dişli Kıymık Cımbızı

Paslanmaz Çelik.
Uzunluk : 16 cm



20267 Eğimli Cımbız

Paslanmaz Çelik.
Uzunluk : 9 cm



20225AG Eğimli Cımbız

Paslanmaz Çelik.
Uzunluk : 9 cm



20285 Otomatik Cımbız

Paslanmaz Çelik.
Uzunluk : 9,5 cm



20143 Geri Cımbız

Paslanmaz Çelik.
Uzunluk : 8 cm



20200 Eğimli Cımbız

Paslanmaz Çelik.
Uzunluk : 9 cm



20144 Geri Cımbız

Paslanmaz Çelik.
Uzunluk : 8 cm



20202 RUCK Elmas Kaplama Cımbız

Paslanmaz Çelik.
Uzunluk : 9,5 cm

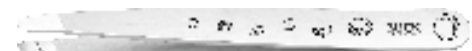

Freze ve Taşlama Uçları

27073 Orta Kalınlıkta Elmas Taşlama

Gr. 055
60.000 max d/dak.



27076 Orta Kalınlıkta Elmas Taşlama

Gr. 060
57.000 max d/dak.



2720247 Orta Kalınlıkta Elmas Taşlama

Gr. 047
70.000 max d/dak.



27248 Kanallı Süper Kalın Elmas Taşlama

Gr. 065
40.000 max d/dak. / Siyah Halkalı



27254 Yan Tutuşlu Elmas Taşlama

Gr. 055
20.000 max d/dak.



27232 Kalın Taçlı Elmas Taşlama

Gr. 050
60.000 max d/dak. / Yeşil Halkalı



27222 Süperkalın Taçlı Elmas Taşlama

Gr. 085
30.000 max d/dak. / Siyah Halkalı



27250 Elmas Taşlama

Gr. 055
20.000 max d/dak. / Kırmızı Halkalı



2727310 Sert Metal Uçlu Yuvarlak Freze / 2 Adet

Gr. 010
30.000 max d/dak. / Yeşil Halkalı



2727312 Sert Metal Uçlu Yuvarlak Freze / 2 Adet

Gr. 012
30.000 max d/dak. / Yeşil Halkalı



2727314 Sert Metal Uçlu Yuvarlak Freze / 2 Adet

Gr. 014
30.000 max d/dak.



* Lütfen Detaylı Freze Listesini Satış Danışmanlarımızdan İsteyiniz.

2727316 Sert Metal Uçlu Yuvarlak Freze / 2 Adet

Gr. 016
30.000 max d/dak. / Yeşil Halkalı



2727318 Sert Metal Uçlu Yuvarlak Freze / 2 Adet

Gr. 018
30.000 max d/dak. / Yeşil Halkalı



2727321 Sert Metal Uçlu Yuvarlak Freze / 2 Adet

Gr. 021
30.000 max d/dak. / Yeşil Halkalı



2727323 Sert Metal Uçlu Yuvarlak Freze / 2 Adet

Gr. 023
30.000 max d/dak. / Yeşil Halkalı



2720350 Çapraz Kesim Tomurcuk Freze, 2 Adet

Paslanmaz Çelik / Gr. 050
16.500 max d/dak.



2702203 Megakalın Taçlı Boynuz Nasır Törpüsü

Gr. 0120
20.000 max d/dak. / Çift Siyah Halkalı



2722701 Süperkalın Taçlı Boynuz Nasır Törpüsü

Gr. 080
20.000 max d/dak. / Siyah Halkalı



2723402 Kalın Taçlı Başlangıç Nasırı Törpüsü

Gr. 095
20.000 max d/dak. / Yeşil Halkalı



2707001 Beyaz Silindir Taşlama

Gr. 100
27.000 max d/dak.



27071 Beyaz Silindir Taşlama, 2 Adet

Gr. 055
50.000 max d/dak.



2714102 Pembe Taşlama, 2 Adet

Gr. 035
85.000 max d/dak.



*Lütfen Detaylı Freze Listesini Satış Danışmanlarımızdan İsteyiniz.

27126 Pembe Taşlama, 2 Adet

Gr. 060
50.000 max d/dak.



2713701 Pembe Taşlama, 2 Adet

Gr. 018
85.000 max d/dak.



2713702 Pembe Taşlama, 2 Adet

Gr. 020
85.000 max d/dak.



2713703 Pembe Taşlama, 2 Adet

Gr. 028
85.000 max d/dak.



27116 Ön Parlaticı, 2 adet

Gr. 060
20.000 max d/dak.



27110 Ön Parlaticı, 2 adet

Gr. 100
15.000 max d/dak.



27111 Parlak Parlaticı

Gr. 060
10.000 max d/dak.



27108 Parlak Parlaticı

Gr. 100
15.000 max d/dak. / Siyah Halkalı



2710P Parlak Parlaticı

Gr. 060
20.000 max d/dak.



27013 Süper İnce Lastik Taşıyıcı

Yuvarlak
Ø 5 mm



2751301 İnce Başlık
2751302 Orta Başlık
2751303 Kalın Başlık



Taşlama / Parlatma ve Set Uçları

27014 Lastik Taşıyıcı

İnce / Yuvarlak
Ø 7 mm



2751402 Orta Başlık
2751403 Kalın Başlık
2760101 Silisyum Karbür Başlık



27002 Lastik Taşıyıcı

Küçük / Yuvarlak / Ø 10 mm



2750201 İnce Başlık
2750202 Orta Başlık
2750203 Kalın Başlık
2760101 Silisyum Karbür Başlık



27005 Lastik Taşıyıcı

Küçük / Yuvarlak / Ø 13 mm



2750201 İnce Başlık
2750202 Orta Başlık
2750203 Kalın Başlık
2760101 Silisyum Karbür Başlık



27009 Lastik Taşıyıcı

Küçük / Yuvarlak / Ø 16 mm



2750901 İnce Başlık
2750902 Orta Başlık
2750903 Kalın Başlık



27052 Aşındırıcı / Törpü
Kap Seti



Freze / Taşlama Uç Setleri

27063 BUSCH Mantar Seti (Mykose Set) / 8 Parça

Mantarlı tırnaklar için en iyi sonuca odaklı, kesin ve hızlı çözüm imkanı sunan bir settir. En iyi sert metal frezeleriyle mantarlı tırnaklara hedeflenen kontürleri yapma imkanı verir ve diğer freze ve öğütücülerle de set tamamlanır.



27061 RUCK Profesyonel Steril Kasalı Evrensel Freze Seti 12 Parça

İşin uzmanları tarafından oluşturulmuştur. Profesyonel steril kasalı 12 parçalı freze uçlarından oluşan settir. Böylece ayak bakımı için gerekli olan tüm farklı çalışma olanakları sağlanmış olur. Döner aletlerde BUSCH adı kalite için her zaman büyük bir üretici konumundadır. Başlıklarda kalibre edilmiş keskin bıçak gücü itinalı bir şekilde bilenmiştir ve en iyi özel çelik kalitesini sunar.

Bu set, 1 adet çaplı bükücü (Dia Twister), 3 adet elmas uçlu taşlama,

1 adet sert metal frezesi ve 7 adet özel çelik frezesinden oluşmaktadır.

Art. No.: 5405090, 85RS060, 424X040, 136RS100, 225RS018, 841035, 1RS010, 11RS010, 11RS016, 39RS009, 850016



* Lütfen Detaylı Freze Listesini Satış Danışmanlarımızdan İsteyiniz.

27064 BUSCH Diabetik Set / 8 Parça

Bu alet takımı, asgari ölçüde müdahale imkanı sağlayarak diabetik ayaklarda uygulama olanağı sunar. Yuvarlaklaştırılmış ve sadece kısmen elmas kaplanmış aletlere yapılan müdahalelerle sağlığa zarar verme riskini en asgariye indirir.



Art. No.: 8840055, 893EF047, 8850016, 801014, 407RS012, 5895065

27065 BUSCH Tırnak Bakım Seti / 9 Parça

Bu alet seti hastalıklı tırnaklarda istenilen bakımı sağlamak için birebirdir.

Form tutturma ve düzleştirme için iki adet elmas aşındırıcı, Tırnak katmanlarını giderici özel frezeler, ayrıca parlak ve düzgün tırnak oluşumu için gerekli tüm aletler bu sette mevcuttur.



Freze / Taşlama Uç Setleri

*Lütfen Detaylı Freze Listesini Satış Danışmanlarımızdan İsteyiniz.

27066 BUSCH İşlem Sonrası Evrensel Set / 9 Parça

Sistemli oluşturulmuş bu set ile diabetik ayaklardaki standart tırnak ve tırnak derisi için çalışabilirsiniz. Elmas düzleyici uçlarla her türlü alanda çalışabilirsiniz. Hiperkeratoz, çatlaklar ve önceki uygulamadan sonra oluşmuş çatlakları gidermek için uygundur.



27169 Freze Magneti



27067 BUSCH Çivi Seti / 8 parçalı / Nasır seti

Farklı alet olanakları ile hedef edilen uygulama odaklı seçim imkanı sunar ve örneğin nasırları gidermek için yetenekli bir settir. Frezelerle üst tabakadaki büyük ve kalın nasırları en ufak tabakadaki nasırlara kadar almak için kalından küçüğe doğru gerekli olan tüm küre frezeleri barındırır.



2759 Başlangıç Seti



27093 Tırnak Parlatma Seti

Temizleme ve uygulama tamamlayıcı için fırça ve parlatma seti. Zımpara tozu ve kalıntılarını çanak şekilli keçi kılı fırçası ile tırnak yüzeyinden temizleyebilirsiniz.

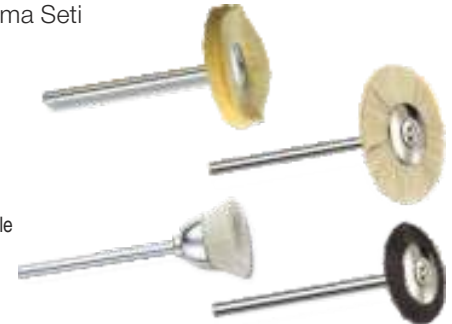

Ortoneksi (Batık Tırnak) Setleri

TEL SETİ



ALTIN TEL SETİ



23067 RUCK TEL SET

- 23060
- 23066
- 23064
- 55451
- 23061
- 26068



Ortoneksi (Batık Tırnak) Setleri

23090 B/S Spange Classic Set

23091 B/S APLİKATÖR
23092 B/S/ BASIC FIRÇA TUTKALI
23093 B/S/ KLASİK
(14,16,18,20,22 ve 24gr.
Her birinden 10 Adet)
23101 B/S/ TEMİZLEYİCİ CLEAN-EX 25ml.



23150 B/S-Spange H-Form Profi-Set

23091 B/S APLİKATÖR
23092 B/S/ BASIC FIRÇA TUTKALI
23096 B/S SIEGELLACK
23153 B/S/ KLASİK
(14,16,18,20,22 ve 24gr.
Her birinden 10 Adet)
23101 TEMİZLEYİCİ CLEAN-EX 25ml.



23147 B/S-Quick, Profi Set

23092 B/S/ BASIC FIRÇA TUTKALI
23148 B/S/ KLASİK
(14,16,18,20,22 ve 24gr. Her birinden 5 Adet)
23101 B/S/ TEMİZLEYİCİ CLEAN-EX 25ml.
23179 B/S KLASİK AKTİVATÖR 10ml.



Alet Setler

21100 Ruck Alet Seti

- 28060 RUCKINSTRUMENTE Tırnak ucu kesici, ,
- 28068 RUCKINSTRUMENTE Köşe pensi
- 28083 RUCKINSTRUMENTE Deri pensi,
- 20600 Bıçak tutucu,
- 20040 Çift taraflı tırnak aleti
- 21005 Tek kullanımlık bez çanta, beyaz, 50 adet
- 20033 Yuvarlatılmış, çift taraflı tırnak aleti



28090 Alet Seti / 3 Parça

- 28068 RUCKINSTRUMENTE Köşe Pensi,
- 28060 RUCKINSTRUMENTE Tırnak ucu kesici,
- 28083 RUCKINSTRUMENTE Deri pensi



21107 Manikür/Pedikür Sihirli Kutulu Seyahat Seti

Ölçüleri : 22 x 115 x 60 mm



37026 RUCKINSTRUMENTEN Set-1 Ağırlık: 260 gram

- 28060 RUCKINSTRUMENTE Tırnak ucu kesici,
- 28068 RUCKINSTRUMENTE köşe pensi
- 28083 RUCKINSTRUMENTE Deri pensi
- 20003 Bisturi Tutucu
- 20600 Bıçak Tutucu
- 20078 Medikal Bıçaklar. 1,2,5 ve 10'dan 5'er Ad.
- 20040 Çift Taraflı Tırnak Aleti
- 20033 Yuvarlatılmış Çift Taraflı Tırnak Aleti
- 2702203 MegaKalın Taçlı Boynuz Nasır Törpüsü
- 27073 Elmas Taşlama
- 2721310 Top Uçlu Freze
- 27100 RUCK Küçük Freze Tutucu

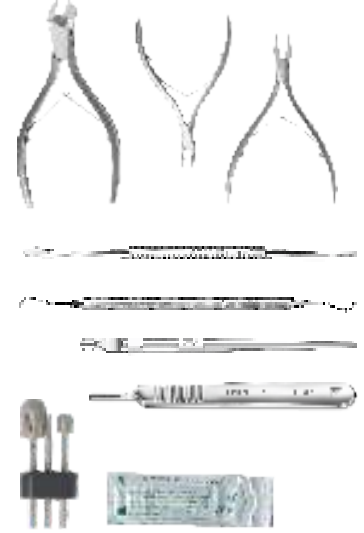

37027 RUCKINSTRUMENTEN Set-2 Ağırlık: 350 gram

- 28060 RUCKINSTRUMENTE Tırnak ucu kesici,
- 28068 RUCKINSTRUMENTE Köşe pensi
- 28083 RUCKINSTRUMENTE Deri pensi
- 20600 Bıçak tutucu,
- 20078 Medikal Bıçaklar
- 20040 Çift taraflı tırnak aleti
- 20033 Yuvarlatılmış, çift taraflı tırnak aleti

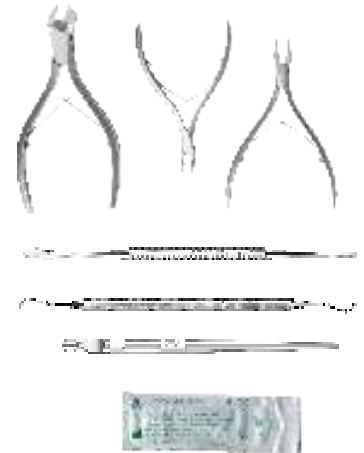

Ortopedik ve Destek Malzemeleri



*Lütfen Detaylı Listeyi Danışmanlarımızdan İsteyiniz.



peclavus® Ayak Sağlık ve Kozmetik Ürünleri Kataloğunu Lütfen İsteyiniz.

www.peclavus.net



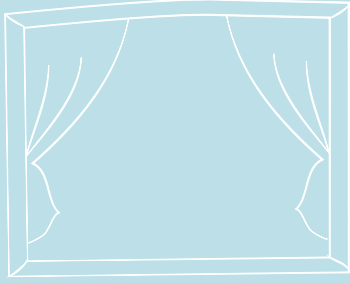

RUCK[®]
FÜR FUSS UND PFLEGE

RUCK AYAK SAĞLIĞI DANIŞMANINIZ :

POFESYONEL AYAK BAKIMI
peclavus[®]

TÜRKİYE DİSTRİBÜTÖRÜ
**ULUS DESTEK HİZMETLERİ DANIŞMANLIK
VE KOZMETİK SANAYİ TİCARET LTD. ŞTİ.**
Seyrantepe Mah. Cesur Sk. No.79/B Kağıthane / İstanbul / Türkiye
Tel : +90 212 283 61 46 • Fax : +90 212 284 96 49

www.ruckayaksagligi.com

SUN'S
Sağlık & Güzellik & Franchising
www.suns.com.tr
info@suns.com.tr